













Typ RE 39.1.1	Typ RE 39.1.2	Typ RE 39.2.1	Typ RE 39.2.2	Typ RE 39.3.1	Typ RE 39.4.1	Typ RE 39.5.1
						

Typ RE 39.6.1	Typ RE 39.7.1	Typ RE 39.8.1	Typ RE 39.9.1	Typ RE 39.10.1	Typ RE 39.11.1
					

Nástavec stolový, otevřený

Podtyp RE 39.1.1 – jednopatrový
Podtyp RE 39.1.2 – dvoupatrový



RE 39.1.1

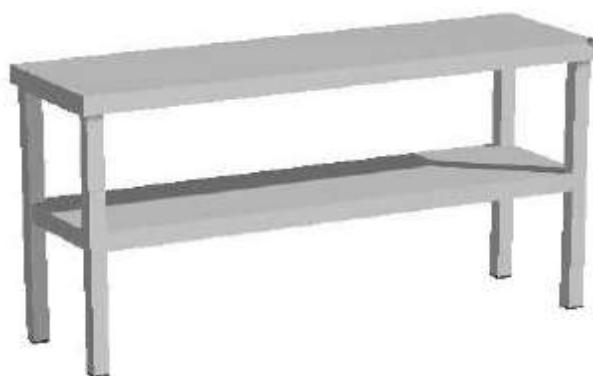

RE 39.1.2

Délka A (mm)	RE 39.1.1		RE 39.1.2	
	šířka 300 mm Cena v Kč (EXW)	šířka 400 mm Cena v Kč (EXW)	šířka 300 mm Cena v Kč (EXW)	šířka 400 mm Cena v Kč (EXW)
400	4075	4375	6288	6725
500	4288	4625	6563	7063
600	4500	4875	6838	7400
700	4713	5125	7125	7738
800	4925	5375	7400	8075
900	5138	5625	7675	8413
1000	5350	5888	7950	8750
1100	5563	6138	8225	9088
1200	5775	6388	8513	9425
1300	5988	6638	8788	9763
1400	6200	6888	9063	10100

Nástavec stolový dvoupatrový, otevřený

Podtyp RE 39.2.1 – jednopatrový

Podtyp RE 39.2.2 – dvoupatrový



RE 39.2.1



RE 39.2.2

Délka A mm	TYP RE 39.2.1		TYP RE 39.2.2	
	šířka 300 mm Cena v Kč (EXW)	šířka 400 mm Cena v Kč (EXW)	šířka 300 mm Cena v Kč (EXW)	šířka 400 mm Cena v Kč (EXW)
1500	7075	7763	10125	11163
1600	7288	7975	10400	11438
1700	7500	8188	10675	11713
1800	7713	8400	10950	11988
1900	7925	8613	11225	12263

Nástavec stolový, uzavřený

Podtyp RE 39.3.1 – nástavec stolový

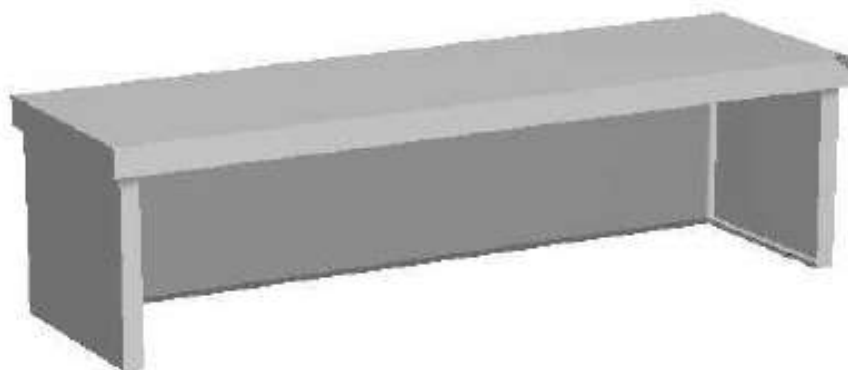

Délka A	šířka 300 mm	šířka 400 mm
mm	Cena v Kč (EXW)	Cena v Kč (EXW)
400	4620	5046
500	4909	5376
600	5184	5720
700	5473	6050
800	5761	6394
900	6050	6724
1000	6325	7054
1100	6614	7398
1200	6903	7728
1300	7178	8071
1400	7466	8401

Podstavce

Podtyp RE 39.4.1 – podnoží pod konvektomat

Podtyp RE 39.4.2 – podstavce

Podtyp RE 39.4.3 – podstavce



RE 39.4.1



RE 39.4.2



RE 39.4.3

TYP RE 39.4.1	
Délka A	šířka 729 mm
(mm)	Cena v Kč (EXW)
838	9350
TYP RE 39.4.2	
Délka A	šířka 600 mm
(mm)	Cena v Kč (EXW)
800	14508

TYP	A*B	Cena v Kč (EXW)
	(mm)	
RE 39.4.3	550*550*500	8500

Držák GN

1/1, 2/1 a nebo 2*1/1

Podtyp RE 39.5.1 – GN 11

Podtyp RE 39.5.2 – GN 12

Podtyp RE 39.5.3 – GN 21



RE 39.5.1

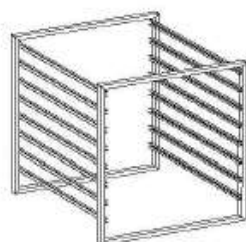

RE 39.5.2

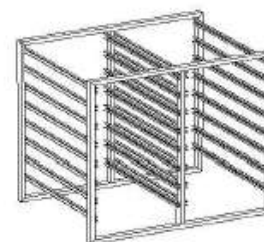

RE 39.5.3

TYP	A*B	Cena v Kč (EXW)
	(mm)	
RE 39.5.1	361*530	4563
RE 39.5.2	566*650	5400
RE 39.5.3	707*530	8638

Lapač slupek, s vyjímatelným košem

Podtyp RE 39.6.1 – L

Podtyp RE 39.6.2 – XL

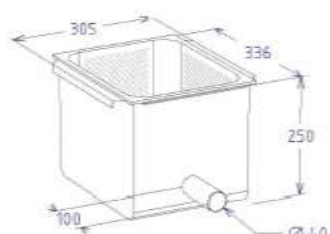

RE39.6.1



RE39.6.2

TYP	Cena v Kč (EXW)
RE 39.6.1	7500
RE 39.6.2	9988

Odkapní miska

Podtyp RE 39.7.1/ RE 39.7.2 – L/XL

Podtyp RE 39.7.3 / RE 39.7.4 – vevařená L/XL

Podtyp RE 39.7.5 / RE 39.7.6 – vevařená s ostřikem L/XL

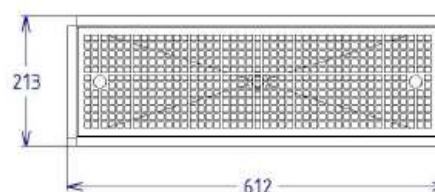
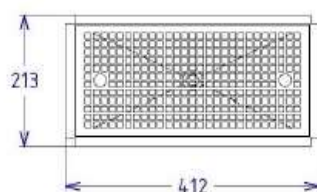
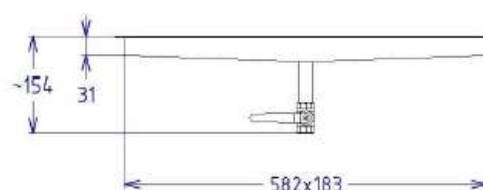
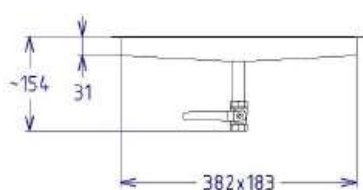
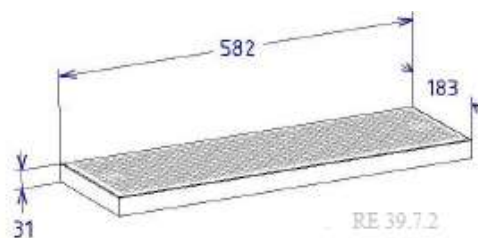
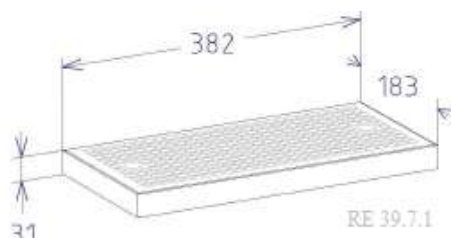

RE 39.7.3

RE 39.7.4

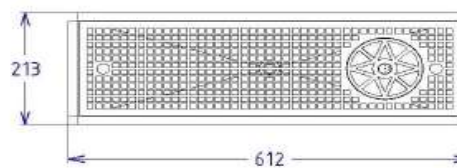
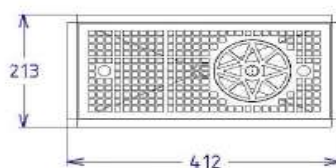
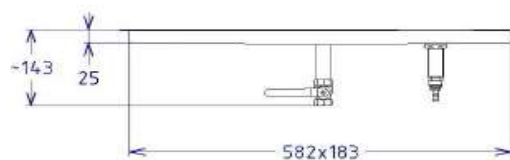
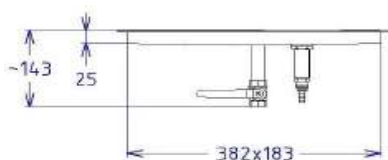

RE 39.7.5

RE 39.7.6

TYP	A*B	Cena v Kč (EXW)
	(mm)	
RE 39.7.1	382*183	1988
RE 39.7.2	582*183	2375
RE 39.7.3	382*183	3925
RE 39.7.4	582*183	4300
RE 39.7.5	382*183	5775
RE 39.7.6	582*183	6138

Podlahová vpust'

Podtyp RE 39.8.1 – L
 Podtyp RE 39.8.2 – XL
 Podtyp RE 39.8.3 – XXL
 Podtyp RE 39.8.4 – 2* XXL

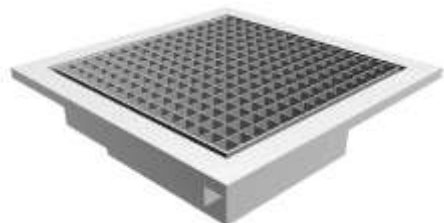

RE 39.8.1



RE 39.8.2



RE 39.8.3



RE 39.8.4

TYP	A*B	Cena v Kč (EXW)
	(mm)	
RE 39.8.1	300*300*150	6900
RE 39.8.1	400*400*150	7600
RE 39.8.2	550*300*150	8100
RE 39.8.2	800*300*150	9500
RE 39.8.2	1050*300*150	10600
RE 39.8.2	1300*300*150	12100
RE 39.8.2	1550*300*150	13500
RE 39.8.2	1800*300*150	14600
RE 39.8.2	2050*300*150	15600
RE 39.8.3	550*300*150	8500
RE 39.8.3	800*300*150	9900
RE 39.8.3	1050*300*150	11300
RE 39.8.3	1300*300*150	12800
RE 39.8.3	1550*300*150	14200
RE 39.8.3	1800*300*150	15400
RE 39.8.3	2050*300*150	16400
RE 39.8.4	800*550*150	14500
RE 39.8.4	1050*550*150	16500
RE 39.8.4	1300*550*150	18500
RE 39.8.4	1550*550*150	20500

Podstavec pod kávovar

Podtyp RE 39.9.1 – podstavec pod kávovar

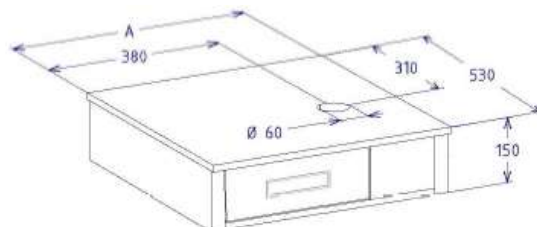

Délka A	Šířka 7530 mm
mm	Cena v Kč (EXW)
520	11700
760	13463
990	15138

Zásuvka, k dodatečnému zabudování

Podtyp RE 39.10.1 – L
 Podtyp RE 39.10.2 – XL
 Podtyp RE 39.10.3 – XXL

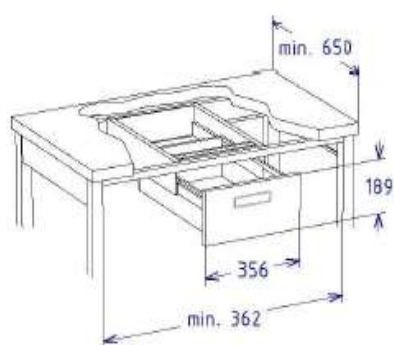
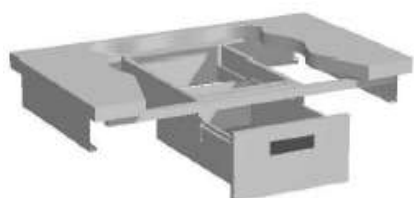

RE 39.10.1

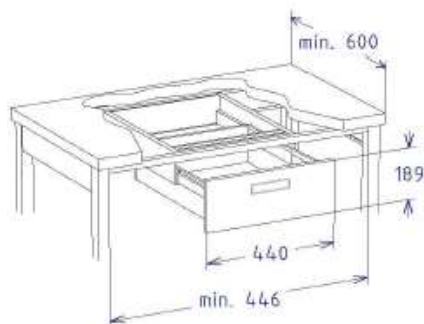

RE 39.10.2

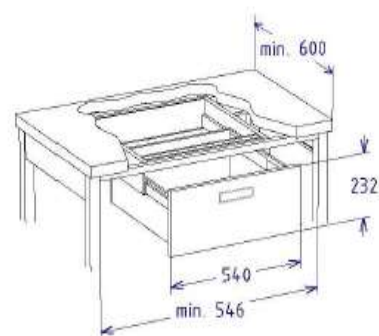

RE 39.10.3

TYP	A*B	Cena v Kč (EXW)
	(mm)	
RE 39.10.1	307*510	4290
RE 39.10.2	391*465	4153
RE 39.10.3	491*465	5005